

# Timing and Synchronization in Packet Networks

by Reza Vaez-Ghaemi, Ph.D.

## Summary

Increasing broadband service penetration demands a transport network that delivers significantly lower cost-per-bit than traditional circuit-switched networks, and Ethernet provides the technology baseline for a cost-effective transport technology. For Ethernet to become a carrier-grade technology in wide area networks (WANs), operators and vendors have introduced several key technologies, including those necessary to address timing and synchronization requirements in WANs.

This paper describes requirements for wide area transport of Time Division Multiplexed (TDM) services with focus on timing and synchronization. Synchronous Ethernet and Precision Time Protocol (PTP) are two key examples of emerging technologies described here.

## Introduction

The ever-increasing demand for broadband services has significantly contributed to the rising average return per user (ARPU) in telecom. Services with the greatest impact include broadcast TV, video on demand (VoD), and mobile Internet. To become profitable, these services require a transport technology with significantly lower cost-per-bit than traditional circuit-switched technology.

Ethernet provides a technology baseline for a cost-effective transport network; however, as a technology originally designed for local area application, it lacks several key attributes for a comprehensive wide area application. For example, frequency synchronization and stability are required at mobile base stations to make efficient use of the radio spectrum and enable handover operations between cell sites.

TDM networks such as synchronous optical network/synchronous digital hierarchy (SONET/SDH) and plesiochronous digital hierarchy (PDH) are based on technologies that can natively carry a timing reference at the physical layer. This feature is driven by the need to carry TDM timing information to enterprise customers and cell sites over packet networks as depicted in Figure 1. The Interworking Function (IWF) converts the TDM services into/from packets at the ingress/egress site. Different approaches are available for IWF depending on the TDM service requirements.

## TDM Service Requirements

TDM services place various requirements on transport networks; some of which are generic and apply to not only TDM but to non-TDM services as well. For example, TDM services require adequate mechanisms for operation, administrative, and maintenance functions (OAM), for monitoring their performance and rapidly identifying and removing problems. Beyond these generic requirements, TDM services require a number of timing and synchronization functions that can vary significantly among various TDM services.

Frequency synchronization indicates provision of the same frequency at different nodes, which is used to recover the timing of TDM services carried over packet networks, also known as circuit emulation service (CES) clock recovery. The requirements can be broken down into long-term accuracy and phase noise (jitter/wander) as specified in the respective service standards. For example, wireless end nodes at Global System for Mobile Communications (GSM)/Universal Mobile Telecommunications System (UMTS) (Base Transceiver Station, BTS/NodeB) retrieve their reference frequency from the network. In order to avoid interference and roaming problems, they require a frequency stability of 50 to 250 parts per billion (ppb).

The term phase synchronization refers to a network condition in which several nodes have access to a reference timing signal whose rising edges occur at the same instant. Time synchronization is the distribution of an absolute time reference to the real-time clocks of a telecommunications network. All the associated nodes have access to information about absolute time and share a common timescale. Distributing time synchronization is one way of achieving phase synchronization. For example, time division duplex (TDD)-based UMTS-based cell sites require inter-cell timing accuracy of better than 2.5  $\mu$ s. Carrying audio and video applications over bridged local area networks (LANs) also requires time synchronization in sub  $\mu$ sec range.

### Mechanisms for TDM Service Transport over Packet Networks

CES is the generic term used for transport (emulation) of services, which can emulate TDM, asynchronous transfer mode (ATM), Multiprotocol Label Switching (MPLS), or other services. This paper focuses on the use of CES for TDM services. Several mechanisms are available for transport of TDM services over packet networks as Figure 1 shows. At the ingress, the IWF converts the TDM payload into packets, which are mapped back to TDM at egress after traversing the Metro Ethernet Network (MEN). Choosing the appropriate mechanism depends on the characteristic of the underlying network and service requirements. The following paragraphs describe the most common CES mechanisms.

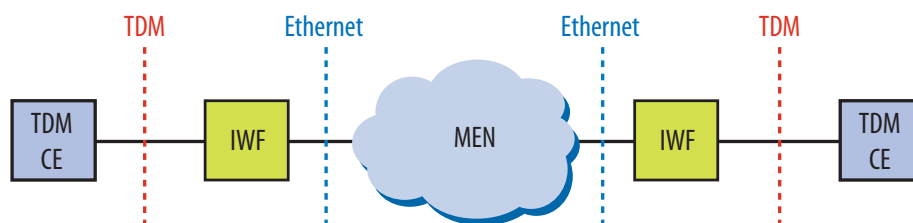

Figure 1: Transport of TDM Services over Packet Networks

#### **PWE3 (IETF RFC 3985)**

Pseudowire Emulation Edge-to-Edge (PWE3) describes the emulation of services such as frame relay, ATM, Ethernet, TDM, and SONET/SDH over packet-switched networks (PSNs) using IP or MPLS. It presents the architectural framework for pseudowires (PWs), defines terminology, and specifies the various protocol elements and their functions. PWE3 is a mechanism that emulates the essential attributes of a telecommunications service (such as a T1 leased line or frame relay) over a PSN.

#### **SATOP (IETF RFC 4553)**

The SATOP document describes the method for encapsulating TDM bit-streams (T1, E1, T3, and E3) as PWs over PSN. It addresses only structure-agnostic transport, that is the protocol completely disregards any structure that may possibly be imposed on these signals, in particular the structure imposed by standard TDM framing (G.704). This emulation is referred to as emulation of unstructured TDM circuits in RFC 4197 and suits applications where the Provider Edge nodes (PE nodes) have no need to interpret TDM data or to participate in the TDM signaling.

***CESoPSN (IETF RFC 5086)***

The CESoPSN document describes a method for encapsulating structured (NxDS0) TDM signals as PWs over PSN. In this regard, it complements similar work for structure-agnostic emulation of TDM bit-streams [RFC4553]. Emulation of NxDS0 circuits provides for saving PSN bandwidth, and supports DS0-level grooming and distributed cross-connect applications. It also enhances resilience of CE devices to the effects of packet loss in the PSN.

***TDM over MPLS: ITU Y.1413***

International Telecommunications Union (ITU) Recommendation Y.1413 focuses on the required functions for network interworking between TDM and MPLS, specifically the user plane interworking mechanisms and procedures for transport. In particular it specifies a list of requirements, interworking scenarios and interworking encapsulation formats and semantics for TDM-MPLS network interworking. Given that TDM connections are inherently point to point, this interworking defines a single connection between two IWFs. This Recommendation only addresses TDM rates up to and including T3 and E3.

**Approaches for Timing and Synchronization**

Carrying timing and frequency synchronization over packet networks can be accomplished in multiple ways with a number of technologies. Ideally, one would have access to Primary Reference Clocks (PRC) at different locations for synchronizing the end nodes. For large networks, several nodes can be provisioned with access to PRC. However, many other nodes must retrieve their reference from those nodes with access to PRC nodes, which can receive their timing information from reference clocks through in-band or out-of-band links.

For in-band mode, payload data is used to carry the timing information. For most accurate and reliable applications, consider out-of-band mode which uses dedicated timing packets that add to the traffic overhead. Examples for out-of-band mode include Network Time Protocol (NTP), PTP, and Synchronous Ethernet described further below.

NTP is one of the oldest Ethernet protocols still in use and is available in two levels: the “standard” version and Simple Network Time Protocol (SNTP) a de-featured subset of NTP. The latest version of NTP, Version 4 (NTPv4) can usually maintain time to within 10–20 ms using traditional software-interrupt-based solutions over the public Internet and can achieve accuracies of microseconds or better in LANs under ideal conditions and the latest generation of timing solutions. NTP has been the most common and arguably the most popular synchronization solution, because it performs well over LANs and WANs and is relatively inexpensive to implement, requiring very little hardware. While NTP should be able to deliver accuracy of 1–2 ms on a LAN and 1–20 ms on a WAN, it is far from guaranteed network-wide largely because of the use of switches and routers and the fact that many NTP clients run on non-real-time operating systems.

## Packet-Based Synchronization Methods

Packet-based methods distribute timing via packets that carry timestamps generated by a master (server) that has access to an accurate reference, such as global positioning system (GPS) to receiving equipment, as Figure 2 shows.

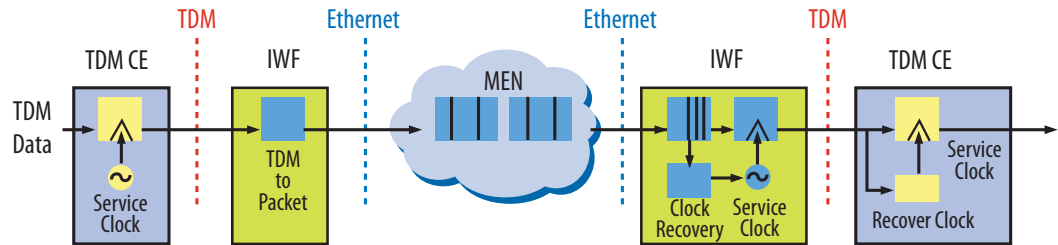

Figure 2: Network Reference Model for Timing Distribution over Packet Networks

The main packet protocols currently defined are NTP and PTP.

## Adaptive and Differential Clock Recovery

The adaptive clock recovery (ACR) methods use the payload data to carry the synchronization data. Self-adaptive clock recovery is a mechanism for deriving a synchronous clock from an asynchronous packet stream. Two IWFs are located between the master clock and the slave clock. The TDM stream is encapsulated into packets by IWF and transferred across a PSN network to the IWF on the other side. First, the packets will be stored in a queue, hereafter referred to as jitter buffer, and then de-encapsulated into TDM stream. It is key for the recovered clock to equal the master clock, or the depth of the jitter buffer must change. The advantage of ACR is that the function is performed at both edges of the Ethernet network with no extra requirement for the switches and routers that are already deployed. The disadvantage of ACR is the frequency accuracy may degrade during traffic congestion.

Some PWE services use ACR as a method to recover frequency when no external reference clocks are available. ACR primarily uses two components, packet arrival rate and fill level of the jitter buffer, as the mechanism to recover and distribute frequency synchronization. However, ACR exhibits major limitations, primarily performance degradation under heavy network utilization, and it also may not meet carrier requirements for phase and time, per the ITU Standards of G.823/G.824 Mean Time Interval Error (MTIE) and Time Deviation (TDEV) masks. ACR also does not provide proper phase alignment or time-of-day information. In addition, ACR coding is proprietary (vendor specific), point-to-point only, non-interoperable, and subject to timing loops.

In Adaptive Clock Recovery mode, the reference clock is only available at the server. The service clock is retrieved at the client by filtering the received packets. In differential clock recovery mode, reference clocks are available at both client and server. One way to accomplish this is to put expensive GPS Stratum 1 clocks at both ends, but this approach is not cost-effective, nor completely desirable, as GPS antennas at remote sites are subject to lightning damage and vandalism.

**IEEE 1588/Precision Timing Protocol, PTP**

Another cost-effective method employs a Stratum 1 PTP Grandmaster clock at the server that ports timing information to isolated PTP slave clocks at clients that then output traditional TDM T1 timing to the installed equipment. This method does not require a forklift upgrade and accounts for all frequency, time, and phases.

PTP, popularly known as IEEE standard 1588, was originally designed to provide precise timing for critical industrial automation. With the new version 2 (IEEE-1588v2), PTP overcomes the Ethernet NTP latency and jitter issues, providing an unprecedented accuracy in the nanosecond range. Network delays and latency are greatly reduced by measuring the round-trip delay between the master and slave clock (client), using a technique where the slave and master communicate with short messages to each other in order to measure and cancel out delay and latency inaccuracies. Previously, expensive GPS-based clocks were required at each cell site to obtain the order of magnitude required for 3G and new 4G services when using IP backhaul. Now it only requires a central Grandmaster clock at the mobile switching center (MSC) and low-cost PTP slave clocks at the cell sites, which greatly lowers both capital and operating costs for carriers.

For accurate network timing two obstacles must be addressed for the transfer of timing information: oscillator drift and latency. Using high-quality oscillators and an accurate source such as a GPS to derive the timing can mitigate oscillator drift. Solving the latency for time information transfer is more challenging with a software/operating system component along with the network latency associated with switches, hubs, and interconnecting cables. PTP helps address the software/operating system component by exchanging time stamp data between master and client nodes.

A time stamping unit (TSU) placed between the media access control (MAC) and physical Ethernet (PHY layer) monitors inbound and outbound traffic and issues a time stamp when it identifies a 1588 packet (Figure 3). The master clock periodically sends a sync message based on its local clock to a slave clock on the network. The TSU marks the exact time the Sync message is sent, and a Follow\_Up message with the exact time information is immediately sent to the slave clock. The slave clock time stamps the arrival of the Sync message, compares the arrival time to the departure time provided in the Follow\_Up, and then can identify the amount of latency in the operating system and adjust its clock accordingly.

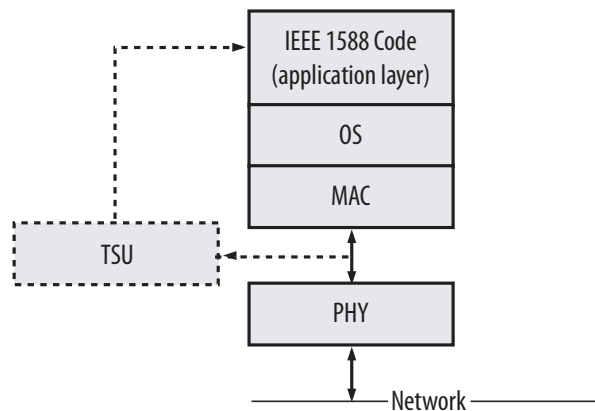

Figure 3: TSU in PTP/1588 Nodes

### Synchronous Ethernet

Synchronous Ethernet provides a mechanism for transferring frequency over the Ethernet physical layer, which is then traceable to an external source such as a network clock. As such, the Ethernet link can be used and is considered part of the synchronization network. Synchronous Ethernet must fit within the general architecture of an Ethernet network. Making use of its ability to transfer timing requires that the Synchronous Ethernet also fit within the general architecture of synchronization networks.

ITU-T Recommendation 8010 describes Ethernet as a two-layer network, the ETH and ETY Layers, as Figure 4 shows. Simply, the ETY layer refers to the physical layer as defined in IEEE 802.3, while the ETH layer represents the pure packet layer. Ethernet MAC frames at the ETH layer are carried as a client of the ETY layer. Various protocols and functionality defined within the IEEE standards are mapped to specific functions within the layer network. In Open Systems Interconnection (OSI) terminology, ETY is Layer 1 and ETH Layer 2.

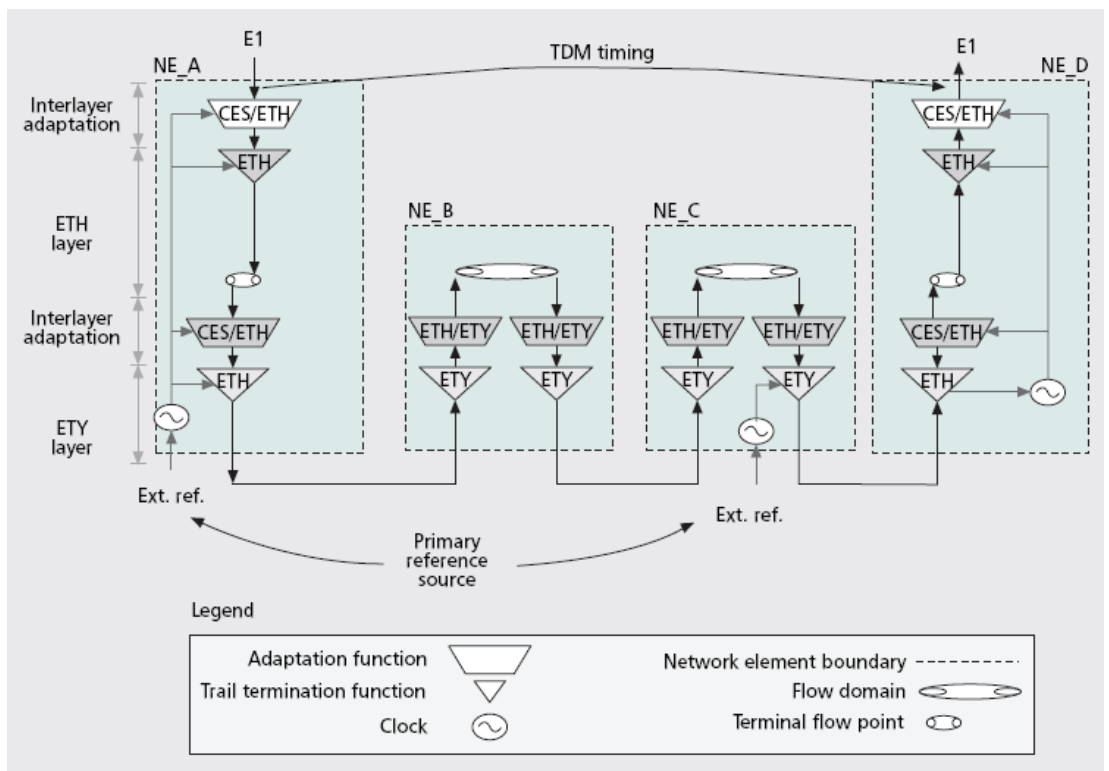

Figure 4: Reference Clocks in Synchronous Ethernet Networks

Synchronous Ethernet has a limited offset range of 4.6 ppm, unlike the (native) IEEE 802.3 Ethernet limit of 100 ppm. Synchronous Ethernet interfaces can operate in sync or non-sync operation mode.

In non-sync mode, Synchronous Ethernet is identical to IEEE 802.3 and can interwork with conventional Ethernet interfaces. The receiver does not pass thru the recovered clock to the transmitter/system clock. The transmitter may be synchronized to an Ethernet Equipment Clock, but appears unknown for the receiving node.

In sync operation mode, the transmitter is locked to 4.6 ppm; the receiver recovers it and passes it to the system/transmitter clock. In this mode, the interface does not work over native Ethernet interfaces.

To enable communication between various nodes, Synchronous Ethernet provides for an Ethernet Synchronization Status Messaging (ESMC, G.8264) channel; similar to SONET/SDH Synchronization Status Messaging (SSM) bytes that allow nodes to deliver their synchronization status to downstream nodes. The downstream nodes use this information to select between various references or possibly switch to their internal clock in rare cases of failure on both reference clocks.

As a large base of installed SONET/SDH synchronization networks exist, Synchronous Ethernet equipment must operate with this network, as specified in G.8261 and G.8262.

### Test Applications

Several phenomena in packet networks can affect the performance of packet timing, such as network congestion, outage, and routing changes, causing some disturbance in packet networks that can lead to packet loss, packet delay, and packet jitter (packet delay variation). The JDSU T-BERD®/MTS 6000A/8000, HST-3000, SmartClass™ Ethernet, and ONT-5xx deliver Ethernet and TDM test functionality for metro and access applications in field and lab.

Key factors for verifying packet timing include:

- Connectivity at TDM and packet interfaces
- TDM jitter/wander
- Synchronous Ethernet jitter/wander

### Basic TDM and Packet Test

The very first step in verifying TDM service is to conduct a bit error rate test (BERT) between the end (TDM) nodes, as shown in Figure 5. If bit errors are present, performing various tests within the enclosed packet network such as a basic Ping test can verify connectivity at Ethernet (OAM Loopback) or IP (ICMP Ping) level. Further characterization of the packet network involves testing the throughput, delay, and delay variation (jitter) across the packet network.

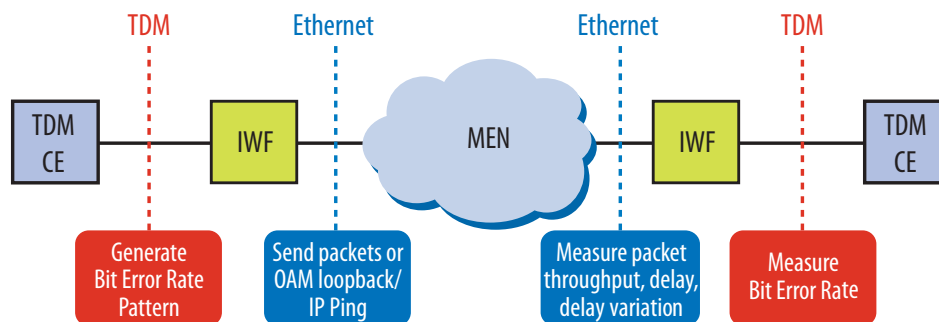

Figure 5: Basic TDM/Packet Test Setup

### TDM Jitter/Wander Measurements

A range of standards including ITU G.823/824 specifies the performance of timing and synchronization nodes in TDM networks, which define the test set ups, test pattern, measurement parameters, as well as the limits for network elements at traffic and synchronization interfaces, as shown in Figure 6.

The JDSU T-BERD 8000 and ONT-5xx product lines conduct jitter/wander measurements from 1.5 M to 43 G in full compliance with respective ITU standards O.171, O.172, and O.173. MTIE and TDEV are key parameters for verifying synchronization function shown in Figure 7.

MTIE is useful in capturing the phase transients in a timing signal, because it describes the maximum phase variation of a timing signal over a period of time. However, MTIE proves inadequate for verifying noise on the timing signal because of its sensitivity to phase transients. TDEV better characterizes random noise because it is a root mean square (RMS) power estimator rather than peak estimator. TDEV tends to remove transients in a timing signal and is, therefore, a better estimator of the underlying noise processes.

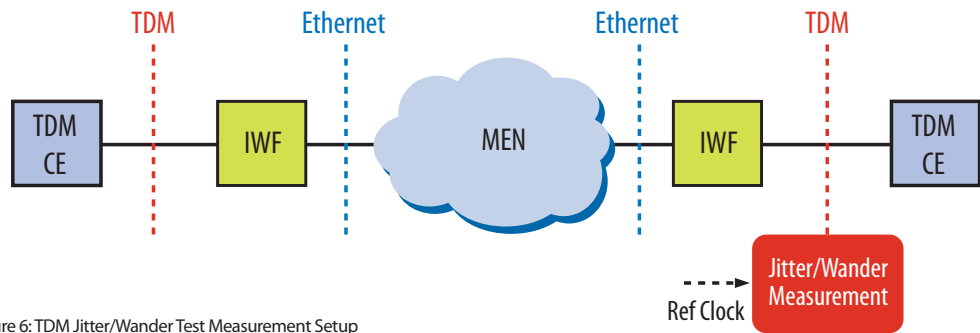

Figure 6: TDM Jitter/Wander Test Measurement Setup

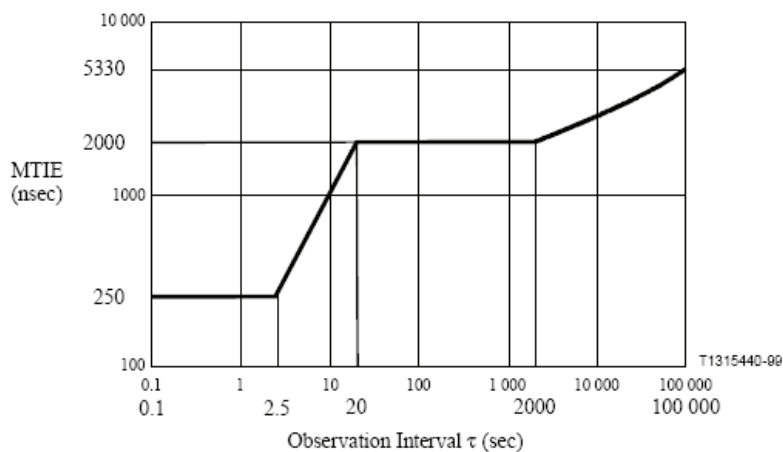

Figure 7: Network Limit for TDM Wander



The ITU specifies requirements for TDM network timing and synchronization limits in standards G.810–813 and G.823. ITU T Recommendation G.8261 defines synchronization aspects in packet networks and specifies the maximum network limits of jitter and wander, which must not be exceeded. G.8261 also specifies the minimum equipment tolerance to jitter and wander that must be provided at the boundary of these packet networks at TDM interfaces. It also outlines the minimum requirements for the synchronization function for network elements.

### Jitter/Wander Measurements at Synchronous Ethernet Interface

The Synchronous Ethernet jitter/wander measurements defined by the ITU are comparable to SONET/SDH measurements and the IEEE 802.3 specifies jitter requirements for asynchronous Ethernet interfaces. However no wander requirement exists for asynchronous Ethernet interfaces.

The ITU G.8262 Recommendation outlines requirements for timing devices used in synchronizing network equipment that uses Synchronous Ethernet. It also defines the requirements for clocks, such as bandwidth, frequency accuracy, holdover, and noise generation.

ITU G.8262 contains two options for Synchronous Ethernet. The first option, referred to as EEC-Option 1, applies to Synchronous Ethernet equipment that is designed to interwork with networks optimized for the 2048 kb/s hierarchy. These networks allow the worst-case synchronization reference chain. The second option, referred to as EEC-Option 2, applies to Synchronous Ethernet equipment that is designed to interwork with networks optimized for the 1544 kb/s hierarchy. The synchronization reference chain for these networks is defined in Appendix II.3 of G.813. G.8262 defines the jitter/wander requirements for EEC Options 1 and 2. ITU O.174 is the emerging as the standard for defining the test methods for Synchronous Ethernet jitter.

JDSU ONT-5xx and Paragon (Calnex solutions) measure jitter at Synchronous Ethernet interfaces in compliance with ITU O.174, which include jitter generation, tolerance, and transfer, as shown in Figure 8.

Technology Application	SDH/SONET/SyncE Synchronous Architecture acc. ITU-T, Telcordia, ANSI	Ethernet Asynchronous Architecture acc. IEEE 802.3
<b>Jitter Generation</b>		
<b>Jitter Tolerance</b> 		
<b>Jitter Transfer</b> 		<p>not applicable</p> <p>DUT Device Under Test</p>

Figure 8: Jitter Measurements at Ethernet and SONET/SDH

---

**Conclusion**

For Ethernet to become a carrier-grade technology in WANs, operators and vendors have introduced several key technologies for transport of timing and synchronization over packet networks, including Adaptive Clock Recovery, Synchronous Ethernet, and Precision Time Protocol (PTP, IEEE 1588). Selection and verification of the appropriate technology requires careful analysis and test in labs and in the field. Verification must include the characterization of jitter/wander performance of the network at TDM and Ethernet interfaces. JDSU is the leading provider of jitter/wander test and measurement products including the ONT, T-BERD®/MTS-8000, and Paragon (Calnex solutions) product lines.

---



---

## References

- ITU-T Recommendation G.823, the control of jitter and wander within digital networks which are based on the 2048 kbit/s hierarchy, 2000.
- ITU-T, G.810. Definitions and terminology for synchronization networks, 1996.
- ITU-T, ITU-T. G.811, Timing requirements of primary reference clocks, 1997.
- ITU-T, G.803. Architecture of transport networks based on the synchronous digital hierarchy (SDH), 2000.
- ITU-T, G.823, The control of jitter and wander within digital networks which are based on the 2048 kbit/s hierarchy, 2000.
- ITU-T, G.824, The control of jitter and wander within digital networks which are based on the 1544 kbit/s hierarchy, 2000.
- ITU-T, G.8262, Timing characteristics of synchronous Ethernet Equipment slave clock (EEC), 2007.
- ITU-T, G.8261 Timing and Synchronization aspects in Packet Networks, 2008.
- ITU-T, G.8264, Distribution of timing through packet networks, 2008.
- IEEE, 1588-PTP, Standard for a Precision Clock Synchronization Protocol for Networked Measurement and Control System, 2008.
- IETF RFC 5086 Structure-Aware Time Division Multiplexed (TDM) Circuit Emulation Service over Packet Switched Network (CESoPSN), 2007.
- IETF RFC 4553 Structure-Agnostic Time Division Multiplexing (TDM) over Packet (SAToP), 2006.
- IETF RFC 1305 Network Timing Protocol (Version 3), 1992.
- IETF RFC 3985 Pseudo Wire Emulation Edge-to-Edge (PWE3) Architecture, 2005.
- Symmetricom, Lee Cosart, Timing Measurements in Packet Networks, 2007.
- JDSU, Andreas Alpert, Jitter and Wander Measurements in Synchronous Ethernet Networks, 2008.
- Calnex Solutions, Tommy Cook, CES-Test – An Alternative ‘Real-World’ Approach, 2009.
- Ericsson, Synchronization in packet-based networks: challenges and solutions, 2009.
-

**Test & Measurement Regional Sales**

<b>NORTH AMERICA</b> TEL: 1 866 228 3762 FAX: +1 301 353 9216	<b>LATIN AMERICA</b> TEL: +1 954 688 5660 FAX: +1 954 345 4668	<b>ASIA PACIFIC</b> TEL: +852 2892 0990 FAX: +852 2892 0770	<b>EMEA</b> TEL: +49 7121 86 2222 FAX: +49 7121 86 1222	<b>WEBSITE: <a href="http://www.jdsu.com/test">www.jdsu.com/test</a></b>
---	--	---	---	--